

## Illuminazione a led

Lampade per uso domestico e industriale

# UltraLux®

La luce intelligente



[www.urmetultralux.it](http://www.urmetultralux.it)

Tel. 011-24.00.835

**urmet**  
ENGINEERING

LISTINO MARZO 2015 Rev 1





## INDICE

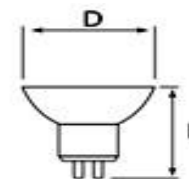





LAMPADINE A LED.....	3
FARETTI A LED.....	13
ADATTATORI/PORTALAMPADE PER LAMPADINE/FARETTI.....	18
GHIERE PER FARETTI DA INCASSO.....	26
TUBI LED T8/T5.....	33
PROIETTORI A LED.....	36
PANNELLI A LED.....	40
LAMPADE INDUSTRIALI/STRADALI A LED.....	51
LAMPADE A LED DA INCASSO.....	54
STRISCE A LED.....	55
ALIMENTATORI PER LED.....	61
CONTROLLER/SENSORI PER LED.....	65
ACCESSORI STRISCE/PROFILI ALLUMINIO.....	75
LAMPADE/PLAFONIERE LED.....	83
BATTERIE.....	91
PRODOTTI INNOVATIVI .....	94







# LAMPADINE A LED

















Legenda:  
L - Altezza  
D - Diametro







Modello	Codice Prodotto	Descrizione	Tensione	Potenza	Attacco	Temperatura Colore	Flusso Luminoso	Dimensione L/D(mm)	Vita (in ore)	Prezzo (IVA esclusa)
	<a href="#">LB122727</a>	Lampadina a LED 2700K E27 220V 12W	220V	12W	E27	2700K	1100 lm	116/60	50.000	<b>10,92 €</b>
	<a href="#">LB122742</a>	Lampadina a LED 4200K E27 220V 12W	220V	12W	E27	4200K	1150 lm	116/60	50.000	<b>10,92 €</b>
	<a href="#">LBB102727D</a>	Lampadina a LED dimmerabile 10W E27 2700K	220V-240V AC	10W	E27	2700K	900 lm	111/60	50.000	<b>14,40 €</b>
	<a href="#">LBB102742D</a>	Lampadina a LED dimmerabile 10W E27 4200K	220V-240V AC	10W	E27	4200K	950 lm	111/60	50.000	<b>14,40 €</b>

Modello	Codice Prodotto	Descrizione	Tensione	Potenza	Attacco	Temperatura Colore	Flusso Luminoso	Dimensione L/D(mm)	Vita (in ore)	Prezzo (IVA esclusa)
	<a href="#">LBB102727</a>	LED bulb 10W E27 2700K	220V-240V AC	10W	E27	2700K	900 lm	111/60	50.000	<b>9,10 €</b>
	<a href="#">LBB102742</a>	LED bulb 10W E27 4200K	220V-240V AC	10W	E27	4200K	950 lm	111/60	50.000	<b>9,10 €</b>
	<a href="#">LPL10E2742</a>	Lampadina LED E27 220V 12 10W 20 SMD 2835	220V	10W	E27	4200K	900 lm	166/40	50.000	<b>16,48 €</b>
	<a href="#">LPL10G2442</a>	Lampadina a LED G24 220V 120 10W 20 SMD 2835	220V	10W	G24	4200K	900 lm	159/40	50.000	<b>16,48 €</b>
	<a href="#">LBB82727</a>	Lampadina a LED 8W E27 2700K	220V-240V AC	8W	E27	2700K	760 lm	98/53	50.000	<b>7,28 €</b>
	<a href="#">LBB82742</a>	Lampadina a LED 8W E27 4200K	220V-240V AC	8W	E27	4200K	800 lm	98/53	50.000	<b>7,28 €</b>







Modello	Codice Prodotto	Descrizione	Tensione	Potenza	Attacco	Temperatura Colore	Flusso Luminoso	Dimensione L/D(mm)	Vita (in ore)	Prezzo (IVA esclusa)
	<a href="#">LB62727</a>	Lampadina a LED 6W E27 2700K	220V-240V AC	6W	E27	2700K	570 lm	110/60	50.000	<b>6,73 €</b>
	<a href="#">LB62742</a>	Lampadina a LED 6W E27 4200K	220V-240V AC	6W	E27	4200K	600 lm	110/60	50.000	<b>6,73 €</b>
	<a href="#">LBC52727</a>	Lampadina a LED 5W E27 2700K, 220V, COB	220V	5W	E27	2700K	500 lm	114/60	30.000	<b>7,28 €</b>
	<a href="#">LBC52742</a>	Lampadina a LED 5W E27 4200K, 220V, COB	220V	5W	E27	4200K	500 lm	114/60	30.000	<b>7,28 €</b>
	<a href="#">LPDV48RGB</a>	RGB LED Party disc with built-in microphone 220V 4.4W	220V	4.4W		RGB		125/35	12.000	<b>14,61 €</b>
	<a href="#">LBC282727</a>	Lampadina a LED 2,8W E27 2700K, 220V	220V	2.8W	E27	2700K	320 lm	114/60	30.000	<b>5,64 €</b>
	<a href="#">LBC282742</a>	Lampadina a LED 2,8W E27 4200K, 220V	220V	2.8W	E27	4200K	320 lm	114/60	30.000	<b>5,64 €</b>





Modello	Codice Prodotto	Descrizione	Tensione	Potenza	Attacco	Temperatura Colore	Flusso Luminoso	Dimensione L/D(mm)	Vita (in ore)	Prezzo (IVA esclusa)
	LPD24RGB	RGB LED Disco Party 220V 2.2W	220V	2.2W		RGB		125/35	12.000	10,84 €
	LB10E2727	LED Lamp - Globo, 10W E27 2700K, 220V	220V	10W	E27	2700K	860 lm	123/95	50.000	12,82 €
	LB10E2742	LED Lamp - Globo, 10W E27 4200K, 220V	220V	10W	E27	4200K	910 lm	123/95	50.000	12,82 €
	LBM5E1427	Lampadina a LED 5W E14 2700K 220V	220V	5W	E14	2700K	500 lm	78/46	50.000	6,79 €
	LBM5E1442	Lampadina a LED 5W E14 4200K 220V	220V	5W	E14	4200K	500 lm	78/46	50.000	6,79 €
	LBM5E2727	Lampadina a LED 5W E27 2700K 220V	220V	5W	E27	2700K	500 lm	78/46	50.000	6,79 €
	LBM5E2742	Lampadina a LED 5W E27 4200K 220V	220V	5W	E27	4200K	500 lm	78/46	50.000	6,79 €







Modello	Codice Prodotto	Descrizione	Tensione	Potenza	Attacco	Temperatura Colore	Flusso Luminoso	Dimensione L/D(mm)	Vita (in ore)	Prezzo (IVA esclusa)
	<a href="#">LB5E2727</a>	Lampadina a LED 5W E27 2700K, 220V	220V	5W	E27	2700K	560 lm	117/80	40.000	<b>7,80 €</b>
	<a href="#">LB5E2742</a>	Lampadina a LED 5W E27 4200K, 220V	220V	5W	E27	4200K	560 lm	117/80	40.000	<b>7,80 €</b>
	<a href="#">LB4E1427</a>	LED Lamp - Ball, 4W E14 2700K, 220V	220V	4W	E14	2700K	350 lm	72/45	50.000	<b>5,20 €</b>
	<a href="#">LB4E1442</a>	Pallina LED, 4W E14 4200K, 220V	220V	4W	E14	4200K	350 lm	72/45	50.000	<b>5,20 €</b>
	<a href="#">LB4E2727</a>	Pallina, 4W E27 2700K, 220V	220V	4W	E27	2700K	350 lm	72/45	50.000	<b>5,20 €</b>
	<a href="#">LB4E2742</a>	Pallina, 4W E27 4200K, 220V	220V	4W	E27	4200K	350 lm	72/45	50.000	<b>5,20 €</b>
	<a href="#">LB2E1427</a>	Mini Pallina LED 2W E14 2700K, 220V	220V	2W	E14	2700K	180 lm	77/45	40.000	<b>5,46 €</b>



Modello	Codice Prodotto	Descrizione	Tensione	Potenza	Attacco	Temperatura Colore	Flusso Luminoso	Dimensione L/D(mm)	Vita (in ore)	Prezzo (IVA esclusa)
	<a href="#">LB2E1442</a>	Mini Pallina LED 2W E14 4200K, 220V	220V	2W	E14	4200K	180 lm	77/45	40.000	5,46 €
	<a href="#">LB2E2727</a>	Mini Pallina LED 2W E27 2700K, 220V	220V	2W	E27	2700K	180 lm	69/45	40.000	5,46 €
	<a href="#">LB2E2742</a>	Mini Pallina LED 2W E27 4200K, 220V	220V	2W	E27	4200K	180 lm	69/45	40.000	5,46 €
	<a href="#">LC4E1427</a>	Candela LED 4W E14 2700K	220V	4W	E14	2700K	350 lm	102/38	50.000	5,20 €
	<a href="#">LC4E1442</a>	Candela LED 4W E14 4200K	220V	4W	E14	4200K	350 lm	102/38	50.000	5,20 €
	<a href="#">LFC221427</a>	LED Fiamma 2.2W E14 2700K, 220V, COB	220V	2.2W	E14	2700K	240 lm	128/37	30.000	6,14 €



Modello	Codice Prodotto	Descrizione	Tensione	Potenza	Attacco	Temperatura Colore	Flusso Luminoso	Dimensione L/D(mm)	Vita (in ore)	Prezzo (IVA esclusa)
	LFC221442	LED Fiamma 2.2W E14 4200K, 220V, COB	220V	2.2W	E14	4200K	240 lm	128/37	30.000	6,14 €
	LF2E1427	LED Candela Tailer 2W E14 2700K, 220V	220V	2W	E14	2700K	180 lm	111/38	40.000	5,46 €
	LF2E1442	LED Candela Tailer 2W E14 4200K, 220V	220V	2W	E14	4200K	180 lm	111/38	40.000	5,46 €
	LP220E14327	Lampadina LED 3W E14 2700K	220V-240V AC	3W	E14	2700K	300 lm	63/18	50.000	9,10 €
	LP220E14342	Lampadina LED 3W E14 4200K	220V-240V AC	3W	E14	4200K	300 lm	63/18	50.000	9,10 €
	LP220G9327	LED Lamp 3W G9 SMD 3014 2700K	220V	3W	G9	2700K	300 lm	60/17	50.000	8,45 €
	LP220G9342	LED Lamp 3W G9 SMD 3014 4200K	220V	3W	G9	4200K	300 lm	60/17	50.000	8,45 €

Modello	Codice Prodotto	Descrizione	Tensione	Potenza	Attacco	Temperatura Colore	Flusso Luminoso	Dimensione L/D(mm)	Vita (in ore)	Prezzo (IVA esclusa)
	LPS12G4227	LED Lamp 2W G4 2700K, 12V DC 2pcs./blister - silicone	12V DC	2W	G4	2700K	140 lm	34/9	30.000	8,84 €
	LPS12G4242	LED Lamp 2W G4 4200K, 12V DC 2pcs./blister - silicone	12V DC	2W	G4	4200K	140 lm	34/9	30.000	8,84 €
	LP220G9227	LED Lamp 2W G9 2700K, 220V	220V	2W	G9	2700K	230 lm	57/22	40.000	5,46 €
	LPS220G9242	LED lamp G9 2W 4200K	220V-240V AC	2W	G9	4200K	200 lm	48/11	50.000	6,79 €
	LPS220G9227	LED lamp G9 2W 2700K	220V-240V AC	2W	G9	2700K	200 lm	48/11	50.000	6,79 €





Modello	Codice Prodotto	Descrizione	Tensione	Potenza	Attacco	Temperatura Colore	Flusso Luminoso	Dimensione L/D(mm)	Vita (in ore)	Prezzo (IVA esclusa)
	LPM12G4227	LED Lamp 2W G4 2700K, 12V DC 2pcs./blister	12V DC	2W	G4	2700K	140 lm	36/32	40.000	6,97 €
	LPM12G4242	LED Lamp 2W G4 4200K, 12V DC 2pcs./blister	12V DC	2W	G4	4200K	140 lm	36/32	40.000	6,97 €
	LR50E1427	Riflettore LED R50 5W E14 2700K, 220V	220V	5W	E14	2700K	380 lm	86/50	40.000	7,25 €
	LR50E1442	Riflettore LED R50 5W E14 4200K, 220V	220V	5W	E14	4200K	380 lm	86/50	40.000	7,25 €
	LR50E1427	Riflettore LED R50 2W E14 2700K, 220V	220V	2W	E14	2700K	180 lm	86/50	40.000	4,99 €
	LR50E1442	Riflettore LED R50 2W E14 4200K, 220V	220V	2W	E14	4200K	180 lm	86/50	40.000	4,99 €

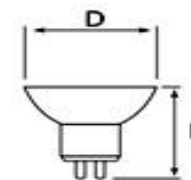





Modello	Codice Prodotto	Descrizione	Tensione	Potenza	Attacco	Temperatura Colore	Flusso Luminoso	Dimensione L/D(mm)	Vita (in ore)	Prezzo (IVA esclusa)
	<a href="#">LP56121560</a>	LED lamp PAR56 neutral 12V AC/DC 150 15W 240 SMD 3528	12V AC/DC	15W		6000K	1100 lm	110/175	50.000	<b>51,79 €</b>
	<a href="#">LAR12G531527</a>	LED Lamp AR111 15W G53 2700K, 12V AC/DC	12V AC/DC	15W	G53	2700K	800 lm	68/111	50.000	<b>27,59 €</b>







# FARETTI A LED









Legenda:  
L - Altezza  
D - Diametro





Modello	Codice Prodotto	Descrizione	Tensione	Potenza	Attacco	Temperatura Colore	Flusso Luminoso	Dimensione L/D(mm)	Vita (in ore)	Prezzo (IVA esclusa)
	<a href="#">LD22010627</a>	LED spotlight 6W GU10 2700K, warm light	220V-240V AC	6W	Gu10	2700K	550 lm	54/50	50.000	<b>9,72 €</b>
	<a href="#">LD22010642</a>	LED spotlight 6W GU10 4200K, neutral light	220V-240V AC	6W	Gu10	4200K	550 lm	54/50	50.000	<b>9,72 €</b>
	<a href="#">LG22010627</a>	LED spotlight 6W GU10 2700K	220V-240V AC	6W	Gu10	2700K	520 lm	60/50	50.000	<b>9,72 €</b>
	<a href="#">LG22010642</a>	LED spotlight 6W GU10 4200K	220V-240V AC	6W	Gu10	4200K	520 lm	60/50	50.000	<b>9,72 €</b>

Modello	Codice Prodotto	Descrizione	Tensione	Potenza	Attacco	Temperatura Colore	Flusso Luminoso	Dimensione L/D(mm)	Vita (in ore)	Prezzo (IVA esclusa)
	<a href="#">LS220106527D</a>	Faretto a LED dimmerabile GU10 220V 2700K 45 6.5W	220V	6.5W	Gu10	2700K	580 lm	57/50	50.000	<b>12,90 €</b>
	<a href="#">LS220106542D</a>	Faretto a LED dimmerabile GU10 220V 4200K 45 6.5W	220V	6.5W	Gu10	4200K	600 lm	57/50	50.000	<b>12,90 €</b>
	<a href="#">L1S22010427</a>	Faretto LED 4W, GU10, 220V, 18 SMD2835, warm light	220V	4W	Gu10	2700K	320 lm	64/50	50.000	<b>6,50 €</b>
	<a href="#">L1S22010442</a>	Faretto LED 4W, GU10, 220V, 18 SMD2835, neutral light	220V	4W	Gu10	4200K	340 lm	64/50	50.000	<b>6,50 €</b>
	<a href="#">LG1216642</a>	LED spotlight 6W MR16 4200K	12V DC	6W	4200K	520 lm	50/50	/	50.000	<b>9,62 €</b>
	<a href="#">L2S22016442</a>	LED spotlight 4200 MR16 220V 120° 4W SMD 2835	220V-240V AC	4W	4200K	340 lm	52/50	/	50.000	<b>6,50 €</b>



Modello	Codice Prodotto	Descrizione	Tensione	Potenza	Attacco	Temperatura Colore	Flusso Luminoso	Dimensione L/D(mm)	Vita (in ore)	Prezzo (IVA esclusa)
	<a href="#">L1S1216427</a>	Faretto LED 4W MR16 2700K, 12V DC	12V DC	4W	MR16	2700K	320 lm	55/50	50.000	6,50 €
	<a href="#">L1S1216442</a>	Faretto LED 4W MR16 4200K, 12V DC	12V DC	4W	MR16	4200K	340 lm	55/50	50.000	6,50 €
	<a href="#">L1S22016427</a>	Faretto LED 4W MR16 2700K, 220V	220V	4W	MR16	2700K	320 lm	55/50	50.000	6,50 €
	<a href="#">L1S22016442</a>	Faretto LED 4W, 220V, 18 SMD2835, neutral light	220V	4W	MR16	4200K	340 lm	55/50	50.000	6,50 €
	<a href="#">L220GU103542</a>	Faretto LEDs 3.5W GU10 4200K 220V	220V	3.5W	Gu10	4200K	280 lm	58/48	50.000	5,28 €
	<a href="#">L12MR163527</a>	Faretto LED 3.5W MR16 12VDC 2700K	12V DC	3.5W	MR16	2700K	280 lm	48/50	50.000	5,28 €

Modello	Codice Prodotto	Descrizione	Tensione	Potenza	Attacco	Temperatura Colore	Flusso Luminoso	Dimensione L/D(mm)	Vita (in ore)	Prezzo (IVA esclusa)
	<a href="#">L12MR163542</a>	Faretto LEDs 3.5W MR16 4200K 12VDC	12V DC	3.5W	MR16	4200K	280 lm	48/50	50.000	5,28 €
	<a href="#">L220MR163527</a>	Faretto LEDs 3.5W MR16 2700K 220V	220V	3.5W	MR16	2700K	280 lm	48/50	50.000	5,28 €
	<a href="#">L220MR163542</a>	Faretto LEDs 3.5W MR16 4200K 220V	220V	3.5W	MR16	4200K	280 lm	48/50	50.000	5,28 €
	<a href="#">L12MR11227</a>	Faretto LED 2W MR11 2700K, 12V AC/DC	12V DC	2W	MR11	2700K	180 lm	39/35	40.000	3,77 €
	<a href="#">L220GU10227</a>	Faretto LED 2W Gu10 2700K, 220V	220V	2W	Gu10	2700K	180 lm	58/50	40.000	4,81 €
	<a href="#">L220GU10242</a>	Faretto LED 2W Gu10 4200K, 220V	220V	2W	Gu10	4200K	180 lm	58/50	40.000	4,81 €







Modello	Codice Prodotto	Descrizione	Tensione	Potenza	Attacco	Temperatura Colore	Flusso Luminoso	Dimensione L/D(mm)	Vita (in ore)	Prezzo (IVA esclusa)
	L12MR16227	Faretto LED 2W MR16 2700K, 12V AC/DC	12V DC	2W	MR16	2700K	180 lm	48/50	40.000	4,81 €
	L12MR16242	Faretto LED 2W MR16 4200K, 12V AC/DC	12V DC	2W	MR16	4200K	180 lm	48/50	40.000	4,81 €
	L220MR16227	Faretto LED 2W MR16 2700K, 220V	220V	2W	MR16	2700K	180 lm	48/50	40.000	4,81 €
	L220MR16242	Faretto LED 2W MR16 4200K, 220V	220V	2W	MR16	4200K	180 lm	48/50	40.000	4,81 €





# ADATTATORI & PORTALAMPADE PER LAMPADINE/FARETTI

Modello	Codice prodotto	Descrizione	Pezzi per confezione	Prezzo (IVA esclusa)
	PFGU10E14	Adattatore GU10 to E14 (4 pcs.)	4 pcs.	4,94 €
	PFGU10E27	Adattatore GU10 to E27 (4 pcs.)	4 pcs.	4,73 €
	PFE14E27	Adattatore E14 to E27 (4 pcs.)	4 pcs.	3,90 €





	PFE27E14	Adattatore E27 to E14 (4 pcs.)	4 pcs.	4,94 €
	PFE27GU10	Adattatore E27 to GU10 (4 pcs.)	4 pcs.	5,93 €
	PFE40E27	Adattatore E40 to E27 (4 pcs.)	4 pcs.	5,85 €
	PFE27SNW	Portalamapada E27, da parete, angolato, nero	10 pcs.	7,54 €
	PFE27SNB	Portalamapada E27, da parete, angolato, nero	10 pcs.	7,54 €
	PFE27SPB	Portalamapada E27, da parete, dritto, nero	10 pcs.	7,54 €

	<a href="#">PFE27SPW</a>	Portalamapada E27, da parete, dritto bianco	10 pcs.	<b>7,54 €</b>
	<a href="#">PFE14CRB1</a>	Portalamapada E14, tutta filettata, nera	1 pcs.	<b>0,65 €</b>
	<a href="#">PFE14CRB</a>	Portalamapada E14, tutta filettata, nera	50 pcs.	<b>17,89 €</b>
	<a href="#">PFE14CRW1</a>	Portalamapada E14, tutta filettata, bianca	1 pcs.	<b>0,65 €</b>
	<a href="#">PFE14CRW</a>	Portalamapada E14, tutta filettata, bianca	50 pcs.	<b>17,89 €</b>

	<a href="#">PFE14PRB1</a>	Portalampada E14, metà filettata, nera	1 pcs.	<b>0,65 €</b>
	<a href="#">PFE14PRB</a>	Portalampada E14, metà filettata, nera	50 pcs.	<b>21,19 €</b>
	<a href="#">PFE14PRW1</a>	Portalampada E14, metà filettata, bianca	1 pcs.	<b>0,65 €</b>
	<a href="#">PFE14PRW</a>	Portalampada E14, metà filettata, bianca (50pcs.)	50 pcs.	<b>26,36 €</b>

	PFE14GB1	Portalampada E14, liscia, nera	1 pcs.	0,57 €
	PFE14GB	Portalampada E14, liscia, nera	50 pcs.	15,05 €
	PFE14GW	Portalampada E14, liscia, bianca	50 pcs.	15,05 €
	PFE14GW1	Portalampada E14, liscia, bianca	1 pcs.	0,57 €





	<a href="#">PFE27CRB1</a>	Portalampada E27, tutta filettata, nera	1 pcs.	<b>0,81 €</b>
	<a href="#">PFE27CRB</a>	Portalampada E27, tutta filettata, nera	50 pcs.	<b>25,90 €</b>
	<a href="#">PFE27CRW1</a>	Portalampada E27, tutta filettata, bianca	1 pcs.	<b>0,81 €</b>
	<a href="#">PFE27CRW</a>	Portalampada E27, tutta filettata, bianca	50 pcs.	<b>33,90 €</b>
	<a href="#">PFE27PRB1</a>	Portalampada E27, metà filettata, nera	1 pcs.	<b>0,86 €</b>
	<a href="#">PFE27PRB</a>	Portalampada E27, metà filettata, nera	50 pcs.	<b>28,24 €</b>





	<a href="#">PFE27PRW1</a>	Portalampada E27, metà filettata, bianca	1 pcs.	<b>0,86 €</b>
	<a href="#">PFE27PRW</a>	Portalampada E27, metà filettata, bianca (50pcs.)	50 pcs.	<b>33,90 €</b>
	<a href="#">PFE27GB1</a>	Portalampada E27, liscia, nera	1 pcs.	<b>0,70 €</b>
	<a href="#">PFE27GB</a>	Portalampada E27, liscia, nera	50 pcs.	<b>21,19 €</b>
	<a href="#">PFE27GW1</a>	Portalampada E27, liscia, bianca	1 pcs.	<b>0,70 €</b>













	<a href="#">PFE27GW</a>	Portalampada E27, liscia, bianca	50 pcs.	<b>27,30 €</b>
	<a href="#">ZKSTKB</a>	Cavo elettrico con spina e interruttore, nero	100	<b>2,37 €</b>
	<a href="#">ZKSTKW</a>	Cavo elettrico con spina e interruttore, bianco	100	<b>2,37 €</b>
	<a href="#">KW2PM19</a>	Waterproof M19 connector, 2 pins, IP67, 10 pcs.	50	<b>84,73 €</b>
	<a href="#">KW3PL20</a>	Waterproof L20 connector, 3 pins, IP67, 10 pcs.	50	<b>65,91 €</b>
	<a href="#">KW3PT20</a>	Waterproof T20 connector, 3 pins, IP67, 10 pcs.	20	<b>98,88 €</b>





# GHIERE PER FARETTI DA INCASSO





Modello	Codice Prodotto	Descrizione	Tipo	Colore	Grado protezione	Diametro (mm)	Apertura foro (mm)	Prezzo (IVA esclusa)
	<a href="#">LVSZNRG4SN</a>	Ghiera, fissa, G4, IP20, nichel satinato, G4	fissa	nichel satinato	non resistente all'acqua IP20	33	27	<b>2,17 €</b>
	<a href="#">LVSMR16WH</a>	Ghiera, fissa, IP20, MR16, bianca	fissa	bianca	non resistente all'acqua IP20	78	65	<b>1,65 €</b>
	<a href="#">LVSMR16CH</a>	Ghiera, fissa, IP20, MR16, cromata	fissa	cromata	non resistente all'acqua IP20	78	65	<b>2,35 €</b>
	<a href="#">LVSMR16PCH</a>	Ghiera, fissa, IP20, MR16, pearl cromata	fissa	cromata	non resistente all'acqua IP20	78	65	<b>2,49 €</b>





Modello	Codice Prodotto	Descrizione	Tipo	Colore	Grado protezione	Diametro (mm)	Apertura foro (mm)	Prezzo (IVA esclusa)
	LVSMR16SN	Ghiera, fissa, IP20, MR16, satin nichel	fissa	satin nichel	non resistente all'acqua IP20	78	65	2,35 €
	LVPMR16WH	Ghiera, orientabile, IP20, MR16, bianca	orientabile	bianca	non resistente all'acqua IP20	81	75	2,73 €
	LVPMR16CH	Ghiera, orientabile, IP20, MR16, cromata	orientabile	cromata	non resistente all'acqua IP20	81	75	3,36 €
	LVPMR16PCH	Ghiera, orientabile, IP20, MR16, pearl cromata	orientabile	cromata	non resistente all'acqua IP20	81	75	3,50 €
	LVPMR16SN	Ghiera, orientabile, IP20, MR16, satin nichel	orientabile	satin nichel	non resistente all'acqua IP20	81	75	3,36 €

Modello	Codice Prodotto	Descrizione	Tipo	Colore	Grado protezione	Diametro (mm)	Apertura foro (mm)	Prezzo (IVA esclusa)
	<a href="#">LVSMR16GUG</a>	Ghiera, fissa, IP20, MR16, grafite-oro	fissa	oro	non resistente all'acqua IP20	78	65	<b>3,82 €</b>
	<a href="#">LVSMR16GUN</a>	Ghiera, fissa, IP20, MR16, grafite-nichel	fissa	grafite	non resistente all'acqua IP20	78	65	<b>3,82 €</b>
	<a href="#">LVSMR16PCHN</a>	Ghiera, fissa, IP20, MR16, pearl cromata-nichel	fissa	cromata	non resistente all'acqua IP20	78	65	<b>3,82 €</b>
	<a href="#">LVSMR16SNG</a>	Ghiera, fissa, IP20, MR16, satin nichel-oro	fissa	satin nichel	non resistente all'acqua IP20	78	65	<b>3,82 €</b>
	<a href="#">LVSMR16SNN</a>	Ghiera, fissa, IP20, MR16, satin nichel/nichel	fissa	satin nichel	non resistente all'acqua IP20	78	65	<b>3,82 €</b>

Modello	Codice Prodotto	Descrizione	Tipo	Colore	Grado protezione	Diametro (mm)	Apertura foro (mm)	Prezzo (IVA esclusa)
	LVPMR16GUG	Ghiera, orientabile, IP20, MR16, grafite-oro	orientabile	grafite	non resistente all'acqua IP20	81	75	4,48 €
	LVPMR16GUN	Ghiera, orientabile, IP20, MR16, grafite-nichel	orientabile	grafite	non resistente all'acqua IP20	81	75	4,48 €
	LVPMR16PCHN	Ghiera, orientabile, IP20, MR16, pearl cromata-nichel	orientabile	cromata	non resistente all'acqua IP20	81	75	4,48 €
	LVPMR16SNG	Ghiera, orientabile, IP20, MR16, satin nichel-oro	orientabile	oro	non resistente all'acqua IP20	81	75	4,48 €
	LVPMR16SNN	Ghiera, orientabile, IP20, MR16, satin nichel-nichel	orientabile	satin nichel	non resistente all'acqua IP20	81	75	4,48 €





Modello	Codice Prodotto	Descrizione	Tipo	Colore	Grado protezione	Diametro (mm)	Apertura foro (mm)	Prezzo (IVA esclusa)
	LVPDMR16SB	Ghiera, orientabile, IP20, MR16, satin brass	orientabile	brass	non resistente all'acqua IP20	92	75	4,87 €
	LVPDMR16SC	Ghiera, orientabile, IP20, MR16, rame satinato	orientabile	copper	non resistente all'acqua IP20	92	75	4,87 €
	LVSCDMR16WH	Ghiera, fissa, MR16, IP20, diamond, bianca cristallo	fissa	cristallo	non resistente all'acqua IP20	90	65	11,34 €
	LVSCMR16WH	Ghiera, fissa, MR16, IP20, circolare, bianca cristallo	fissa	cristallo	non resistente all'acqua IP20	90	65	10,78 €
	LVSCSMR16WH	Ghiera, fissa, MR16, IP20, quadrata, bianca cristallo	fissa	cristallo	non resistente all'acqua IP20	95/95	65	10,78 €





Modello	Codice Prodotto	Descrizione	Tipo	Colore	Grado protezione	Diametro (mm)	Apertura foro (mm)	Prezzo (IVA esclusa)
	<a href="#">LVSCSMR16BK</a>	Ghiera, fissa, cristallo nero, MR16, non resistente all'acqua, IP20	fissa	cristallo	non resistente all'acqua IP20	80/80	70	<b>13,69 €</b>
	<a href="#">LVSCSMR16SK</a>	Ghiera, fissa, cristallo affumicato, MR16, non resistente all'acqua IP20	fissa	cristallo	non resistente all'acqua IP20	80/80	70	<b>13,69 €</b>
	<a href="#">LVSCCMR16WH</a>	Ghiera, fissa, white cristallo, MR16, non resistente all'acqua IP20	fissa	cristallo	non resistente all'acqua IP20	80	70	<b>13,30 €</b>
	<a href="#">LVS2E27230SN</a>	Plafoniera da incasso, fissa, E27, 230mm, IP20, satin nichel	fissa	satin nichel	non resistente all'acqua IP20	230	210	<b>13,79 €</b>
	<a href="#">LVS2E27230WH</a>	Plafoniera da incasso, fissa, E27, 230mm, IP20, bianca	fissa	bianca	non resistente all'acqua IP20	230	210	<b>12,53 €</b>





Modello	Codice Prodotto	Descrizione	Tipo	Colore	Grado protezione	Diametro (mm)	Apertura foro (mm)	Prezzo (IVA esclusa)
	LVSBMR16CH	Plafoniera da incasso, fissa, IP44, MR16, cromata	fissa	cromata	waterproof IP44	92	75	5,71 €
	LVSBMR16SN	Plafoniera da incasso, fissa, IP44, MR16, nichel	fissa	satin nichel	waterproof IP44	92	75	5,71 €
	LVSBMR16WH	Plafoniera da incasso, fissa, IP44, MR16, bianca	fissa	bianca	waterproof IP44	92	75	4,76 €
	PFGU10W	Attacco in porcellana GU10, bianco 50 pcs					Pezzi per pacchetto 50 pcs.	20,93 €







# TUBI T8/T5 LED



Modello	Codice prodotto	Descrizione	Tensione	Potenza	Attacco	Temperatura	Flusso Luminoso	Dimensione L/D(mm)	Durata in ore	Prezzo (IVA esclusa)
	LST82242	Tubo a LED T8 G13 220V 4200K 22W	220V	22W	G13	4200K	2200 lm	1500/31	50.000	31,68 €
	LST82260	Tubo a LED T8 G13 220V 6000K 22W	220V	22W	G13	6000K	2200 lm	1500/31	50.000	31,68 €
	LST81842	Tubo a LED T8 G13 220V 18W	220V	18W	G13	4200K	1800 lm	1200/31	50.000	21,42 €
	LST81860	Tubo a LED T8 G13 220V 6000K 18W	220V	18W	G13	6000K	1800 lm	1200/31	50.000	21,42 €





	LST8942	Tubo a LED T8 G13 220V 4200K 9W	220V	9W	G13	4200K	900 lm	600/31	50.000	14,60 €
	LST8960	Tubo a LED T8 G13 220V 6000K 9W	220V	9W	G13	6000K	900 lm	600/31	50.000	14,60 €
	LST51442	Plafoniera lineare a LED T5 220V 4200K 14W	220V	14W	/	4200K	1220 lm	1170/22/3 7	50.000	20,27 €
	LST51460	Plafoniera lineare a LED T5 220V 6000K 14W	220V	14W	/	6000K	1250 lm	1170/22/3 7	50.000	20,27 €
	LST51042	Plafoniera lineare a LED T5 220V 4200K 10W	220V	10W	/	4200K	870 lm	875/22/37	50.000	16,73 €





	LST51060	Plafoniera lineare a LED T5 220V 6000K 10W	220V	10W		6500K	900 lm	875/22/37	50.000	<b>16,73 €</b>
	LST5742	Plafoniera lineare a LED T5 220V 4200K 7W	220V	7W		4200K	630 lm	575/22/37	50.000	<b>13,30 €</b>
	LST5760	Plafoniera lineare a LED T5 220V 6000K 7W	220V	7W		6000K	650 lm	575/22/37	50.000	<b>13,30 €</b>
	LST5442	Plafoniera lineare a LED T5 220V 4200K 4W	220V	4W		4200K	340 lm	315/22/37	50.000	<b>10,15 €</b>
	LST5460	Plafoniera lineare a LED T5 220V 6000K 4W	220V	4W		6000K	360 lm	315/22/37	50.000	<b>10,15 €</b>

# PROIETTORI LED





Modello	Codice Prodotto	Descrizione	Tensione	Potenza	Temperatura Colore	Flusso Luminoso	Dimensione (mm)	Vita (in ore)	Prezzo (IVA esclusa)
	KESP	Staffa per Proiettori LED					//		10,17 €
	SPM2201027	LED floodlight slim IP67 10W 2700K	220V- 240V AC	10W	2700K	750 lm	157/119/43	50.000	11,31 €
	SPM2201064	LED floodlight slim IP67 10W 6400K	220V- 240V AC	10W	6400K	800 lm	157/119/43	50.000	11,31 €
	SPM2202027	LED floodlight slim IP67 20W 2700K	220V- 240V AC	20W	2700K	1500 lm	190/180/47	50.000	24,49 €
	SPM2202064	LED floodlight slim IP67 20W 6400K	220V- 240V AC	20W	6400K	1600 lm	190/180/47	50000	24,49 €

Modello	Codice Prodotto	Descrizione	Tensione	Potenza	Temperatura Colore	Flusso Luminoso	Dimensione (mm)	Vita (in ore)	Prezzo (IVA esclusa)
	<a href="#">SP2202064</a>	Proiettore LED 20W, 6400K, 220V IP 65	220V	20W	6400K	1200 lm	180/155/100	50.000	<b>26,00 €</b>
	<a href="#">SP2203064</a>	Proiettore LED 30W, 6400K, 220V IP65	220V	30W	6400K	1700 lm	225/200/120	30.000	<b>41,91 €</b>
	<a href="#">SP2205064</a>	Proiettore LED 50W, 6400K, 220V IP65	220V	50W	6500K	2800 lm	285/233/153	30.000	<b>58,11 €</b>











Modello	Codice Prodotto	Descrizione	Tensione	Potenza	Temperatura Colore	Flusso Luminoso	Dimensione (mm)	Vita (in ore)	Prezzo (IVA esclusa)
	<a href="#">SPF2201064</a>	Proiettore LED da esterno 10W, 6400K, 220V IP65	85-265V	10W	6400K	900 lm	75/145/50	50.000	<b>25,43 €</b>
	<a href="#">SPF2202064</a>	Proiettore LED da esterno 20W, 6400K, 220V IP65	85-265V	20W	6400K	1800 lm	220/280/80	50.000	<b>48,96 €</b>
	<a href="#">SPF2203064</a>	Proiettore LED da esterno 30W, 6400K, 220V IP65	85-265V	30W	6400K	2700 lm	220/280/80	50.000	<b>59,33 €</b>
	<a href="#">SPF2205064</a>	LED Outdoor floodlight 50W, 6400K, 220V IP65	85-265V	50W	6400K	4500 lm	320/350/105	50.000	<b>89,47 €</b>





Modello	Codice Prodotto	Descrizione	Tensione	Potenza	Temperatura Colore	Flusso Luminoso	Dimensione (mm)	Vita (in ore)	Prezzo (IVA esclusa)
	<a href="#">SPP2201064</a>	Proiettore LED con PIR 10W, 6400K, 220V IP44	220V	10W	6400K	460 lm	185/105/87	30.000	<b>22,13 €</b>
	<a href="#">SPP12202064</a>	PIR LED floodlight slim IP67 20W 6400K	220V-240V AC	20W	6400K	1600 lm	200/180/105	50.000	<b>35,78 €</b>
	<a href="#">SPS2201260</a>	LED floodlight 6000K 220V 120 12W SMD 2835	85-265V	12W	6000K	1100 lm	133/180/57	50.000	<b>32,01 €</b>
	<a href="#">SPS2203060</a>	Proiettore LED 6000K 85-265V 120 30W SMD2835	85-265V	30W	6000K	3000 lm	178/215/81	50.000	<b>68,74 €</b>
	<a href="#">SPS2205060</a>	Proiettore LED 6000K 85-265V 120 50W SMD2835	85-265V	50W	6000K	5000 lm	194/253/95	50.000	<b>103,58 €</b>





# PANNELLI LED





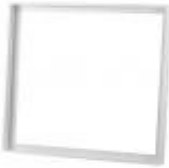

Modello	Codice Prodotto	Descrizione	Potenza	Temperatura	Flusso Luminoso	Dimensioni esterne (mm)	Diametro foro per installazione	Vita (ore)	Prezzo (IVA esclusa)
	KELP82	Accessori per il fissaggio dei pannelli a LED	/	/	/	/	/	/	6,08 €
	LPABS627G	Pannello da incasso da incasso, rotondo, 6W SMD2835, cornice verde, luce calda	6W	2700K	400 lm	140/14	125	50.000	11,14 €
	LPABS627O	Pannello da incasso da incasso, rotondo, 6W SMD2835, cornice arancione, luce calda	6W	2700K	400 lm	140/14	125	50.000	11,14 €
	LPABS627W	Pannello da incasso da incasso, rotondo, 6W SMD2835, cornice bianca, luce calda	6W	2700K	400 lm	140/14	125	50.000	11,14 €











Modello	Codice Prodotto	Descrizione	Potenza	Temperatura	Flusso Luminoso	Dimensioni esterne (mm)	Diametro foro per installazione	Vita (ore)	Prezzo (IVA esclusa)
 	LPABS627Y	Pannello da incasso da incasso, rotondo, 6W SMD2835, cornice gialla, luce calda	6W	2700K	400 lm	140/14	125	50.000	11,14 €
 	LPABS642G		6W	4200K	400 lm	140/14	125	50.000	11,14 €
 	LPABS642O	Pannello da incasso da incasso, rotondo, 6W SMD2835, cornice arancione, luce neutra	6W	4200K	400 lm	140/14	125	50.000	11,14 €
 	LPABS642W	Pannello da incasso da incasso, rotondo, 6W SMD2835, cornice bianca, luce neutra	6W	4200K	400 lm	140/14	125	50.000	11,14 €
 	LPABS642Y	Pannello da incasso da incasso, rotondo, 6W SMD2835, cornice gialla, luce neutra	6W	4200K	400 lm	140/14	125	50.000	11,14 €





Modello	Codice Prodotto	Descrizione	Potenza	Temperatura	Flusso Luminoso	Dimensioni esterne (mm)	Diametro foro per installazione	Vita (ore)	Prezzo (IVA esclusa)
	<a href="#">LPRG1035627</a>	Pannello LED in vetro, rotondo, da incasso, 6W 12 SMD 5730, luce calda	6W	2700K	425 lm	100/35	75	50.000	<b>15,01 €</b>
	<a href="#">LPRG1035642</a>	Pannello LED in vetro, rotondo, da incasso, 6W 12 SMD 5730, luce neutra	6W	4200K	425 lm	100/35	75	50.000	<b>15,01 €</b>
 <b>NEW</b>	<a href="#">LPSB105627</a>	Pannello a LED da incasso, quadrato, 6W, SMD2835, luce calda	6W	2700K	400 lm	105/105	90/90	50.000	<b>10,14 €</b>
 <b>NEW</b>	<a href="#">LPSB105642</a>	Pannello a LED da incasso, quadrato, 6W, SMD2835, luce neutra	6W	4200K	400 lm	105/105	90/90	50.000	<b>10,14 €</b>
	<a href="#">LPSG1035627</a>	Pannello LED in vetro, quadrato, da incasso, 6W 12 SMD 5730, luce calda	6W	2700K	425 lm	100/100/35	75*75	50.000	<b>14,00 €</b>





Modello	Codice Prodotto	Descrizione	Potenza	Temperatura	Flusso Luminoso	Dimensioni esterne (mm)	Diametro foro per installazione	Vita (ore)	Prezzo (IVA esclusa)
	LPSG1035642	Pannello LED in vetro, quadrato, da incasso, 6W 12 SMD 5730, luce neutra	6W	4200K	425 lm	100/100/35	75*75	50.000	14,00 €
	RV66	Frame for building-in of LED panel 600x600				630/630/38			22,32 €
	RVM123	Cornice (da soffitto) per pannello a LED 1200x300				1200/300/50			28,39 €
	RVM66	Cornice (da soffitto) per pannello a LED 600x600				600/600/50			20,27 €
	LP2201234860	Pannello da incasso 48W 6000K con alimentatore IP65	48W	6000K	4000 lm	1196/296/12		50.000	119,67 €

Modello	Codice Prodotto	Descrizione	Potenza	Temperatura	Flusso Luminoso	Dimensioni esterne (mm)	Diametro foro per installazione	Vita (ore)	Prezzo (IVA esclusa)
	LP220664540	Pannello da incasso da incasso 45W 4000K con alimentatore IP65	45W	4000K	3700 lm	595/595/12		50.000	95,31 €
	LP220664560	Pannello da incasso, quadrato, 45W, driver IP65, 216 SMD 2835, luce fredda	45W	6000K	3700 lm	595/595/12	578*578	40.000	95,31 €
	LP664540	Pannello da incasso 45W 4000K SENZA ALIMENTATORE	45W	4000K	3700 lm	595/595/12	578/578	50.000	80,11 €
	LP664560	Pannello da incasso 45W 6000K SENZA ALIMENTATORE	45W	6000K	3700 lm	595/595/12	578/578	50.000	80,11 €
	LP220664240	Pannello LED da incasso 42W 4000K flickerless - ANTI SFARFALLIO	42W	4000K	3500 lm	595/595/9	578/578	50.000	105,48 €
	LP220664255	Pannello LED da incasso 42W 4000K flickerless - ANTI SFARFALLIO	42W	5500K	3500 lm	595/595/9	578/578	50.000	105,48 €





Modello	Codice Prodotto	Descrizione	Potenza	Temperatura	Flusso Luminoso	Dimensioni esterne (mm)	Diametro foro per installazione	Vita (ore)	Prezzo (IVA esclusa)
	<a href="#">LPRB2202442</a>	Pannello da incasso, da incasso, rotondo 24W, SMD5630, luce neutra	24W	4200K	2300 lm	220/25	208	30.000	<b>47,60 €</b>
	<a href="#">LPSB2202442</a>	Pannello da incasso, da incasso, quadrato 24W, SMD5630, luce neutra	24W	4200K	2300 lm	220/220/25	208/208	30.000	<b>47,60 €</b>
	<a href="#">LPRB2251827</a>	Pannello da incasso, da incasso, rotondo 18W, SMD2835, luce calda	18W	2700K	1500 lm	225/12	210	30.000	<b>30,80 €</b>
	<a href="#">LPRB2251842</a>	Pannello da incasso, da incasso, rotondo 18W, SMD2835, luce neutra	18W	4200K	1500 lm	225/12	210	30.000	<b>30,80 €</b>
	<a href="#">LPRG20351827</a>	Pannello LED in vetro, rotondo, da incasso, 18W 36 SMD 5730, luce calda	18W	2700K	1530 lm	200/35	165	50.000	<b>31,44 €</b>
	<a href="#">LPRG20351842</a>	Pannello LED in vetro, rotondo, da incasso, 18W 36 SMD 5730, luce calda	18W	4200K	1530 lm	200/35	165	50.000	<b>31,44 €</b>





Modello	Codice Prodotto	Descrizione	Potenza	Temperatura	Flusso Luminoso	Dimensioni esterne (mm)	Diametro foro per installazione	Vita (ore)	Prezzo (IVA esclusa)
	<a href="#">LPRS2251827</a>	Pannello da incasso surface, rotondo, 18W, SMD2835, luce calda	18W	2700K	1500 lm	225/35		30.000	<b>36,40 €</b>
	<a href="#">LPRS2251842</a>	Pannello da incasso surface, rotondo, 18W, SMD2835, luce neutra	18W	4200K	1500 lm	225/35		30.000	<b>36,40 €</b>
	<a href="#">LPSB2251827</a>	Pannello da incasso, da incasso, quadrato 18W, SMD2835, luce calda	18W	2700K	1500 lm	225/225/12	210/210	30.000	<b>30,80 €</b>
	<a href="#">LPSB2251842</a>	Pannello da incasso, da incasso, quadrato 18W, SMD2835, luce neutra	18W	4200K	1500 lm	225/225/12	210/210	30.000	<b>30,80 €</b>
	<a href="#">LPSG20351827</a>	Pannello LED in vetro, quadrato, da incasso, 18W 36 SMD 5730, luce calda	18W	2700K	1530 lm	200/200/35	165*165	50.000	<b>31,44 €</b>

Modello	Codice Prodotto	Descrizione	Potenza	Temperatura	Flusso Luminoso	Dimensioni esterne (mm)	Diametro foro per installazione	Vita (ore)	Prezzo (IVA esclusa)
	<a href="#">LPSG20351842</a>	Pannello LED in vetro, quadrato, da incasso, 18W 36 SMD 5730, luce neutra	18W	4200K	1530 lm	200/200/35	165*165	50.000	<b>31,44 €</b>
	<a href="#">LPSS2251827</a>	Pannello da incasso surface, quadrato, 18W, SMD2835, luce calda	18W	2700K	1500 lm	225/225/35		30.000	<b>36,40 €</b>
	<a href="#">LPSS2251842</a>	Pannello da incasso surface, quadrato, 18W, SMD2835, luce neutra	18W	4200K	1500 lm	225/225/35		30.000	<b>36,40 €</b>
	<a href="#">LP2202401542</a>	Pannello da incasso, da incasso, rotondo, 15W 180 SMD 3014	15W	4200K	1050 lm	240/15	225	40.000	<b>28,00 €</b>





Modello	Codice Prodotto	Descrizione	Potenza	Temperatura	Flusso Luminoso	Dimensioni esterne (mm)	Diametro foro per installazione	Vita (ore)	Prezzo (IVA esclusa)
	<a href="#">LP2201801242</a>	Pannello da incasso, da incasso, rotondo, 12W, 110 SMD 3014	12W	4200K	850 lm	180/15	165	40.000	<b>22,40 €</b>
	<a href="#">LPRB1801227</a>	Pannello da incasso, da incasso, rotondo 12W, SMD2835, luce calda	12W	2700K	900 lm	180/12	160	30.000	<b>22,40 €</b>
	<a href="#">LPRB1801230</a>	LED panel, built-in, round 12W, SMD2835, 3000K warm light	12W	3000K	900 lm	170/12	150/150	50.000	<b>19,26 €</b>
	<a href="#">LPRG16351227</a>	Pannello LED in vetro, rotondo, da incasso, 12W 24 SMD 5730, luce calda	12W	2700K	1020 lm	160/35	120	50.000	<b>25,20 €</b>
	<a href="#">LPRG16351242</a>	Pannello LED in vetro, rotondo, da incasso, 12W 24 SMD 5730, luce neutra	12W	4200K	1020 lm	160/35	120	50.000	<b>25,20 €</b>











Modello	Codice Prodotto	Descrizione	Potenza	Temperatura	Flusso Luminoso	Dimensioni esterne (mm)	Diametro foro per installazione	Vita (ore)	Prezzo (IVA esclusa)
	<a href="#">LPRS1801227</a>	Pannello da incasso surface, rotondo, 12W, SMD2835, luce calda	12W	2700K	900 lm	180/35		30.000	<b>27,19 €</b>
	<a href="#">LPRS1801242</a>	Pannello da incasso surface, rotondo, 12W, SMD2835, luce neutra	12W	4200K	900 lm	180/35		30.000	<b>27,19 €</b>
	<a href="#">LPSB1801227</a>	Pannello da incasso, da incasso, quadrato 12W, SMD2835, luce calda	12W	2700K	900 lm	180/180/12	160/160	30.000	<b>22,40 €</b>
	<a href="#">LPSB1801242</a>	Pannello da incasso, da incasso, quadrato 12W, SMD2835, luce neutra	12W	4200K	900 lm	180/180/12	160/160	30.000	<b>22,40 €</b>



Modello	Codice Prodotto	Descrizione	Potenza	Temperatura	Flusso Luminoso	Dimensioni esterne (mm)	Diametro foro per installazione	Vita (ore)	Prezzo (IVA esclusa)
	<a href="#">LPSG16351227</a>	Pannello LED in vetro, quadrato, da incasso, 12W 24 SMD 5730, luce calda	12W	2700K	1020 lm	160/160/35	120*120	50.000	<b>25,20 €</b>
	<a href="#">LPSG16351242</a>	Pannello LED in vetro, quadrato, da incasso, 12W 24 SMD 5730, luce neutra	12W	4200K	1020 lm	160/160/35	120*120	50.000	<b>25,20 €</b>
	<a href="#">LPSS1801227</a>	Pannello da incasso surface, quadrato, 12W, SMD2835, luce calda	12W	2700K	900 lm	180/180/35		30.000	<b>27,19 €</b>
	<a href="#">LPSS1801242</a>	Pannello da incasso surface, quadrato, 12W, SMD2835, luce neutra	12W	4200K	900 lm	180/180/35		30.000	<b>27,19 €</b>

# LED INDUSTRIALI E STRADALI





Modello	Codice Prodotto	Descrizione	Tensione	Potenza	Temperatura	Flusso Luminoso	Dimensione (mm)	Vita (ore)	Prezzo (IVA esclusa)
	LUT2202045	Lampada stradale a LED 220V 20W 4500K IP65	220V- 240V AC	20W	4500K	2000 lm	325/130/75	50.000	81,93 €
	LIKG20060	Campana industriale a LED 220V 200W 6000K IP54	100-240V	200W	6000K	18400 lm	304/260/	50.000	508,48 €
	LIKR100	Riflettore 100° per campana industriale a LED cod. LIKG20060					378/108/		11,31 €
	LIKG10060	Campana industriale a LED 220V 100W 6000K IP54	220V	100W	6000K	10000 lm	210/300/	50.000	207,17 €

Modello	Codice Prodotto	Descrizione	Tensione	Potenza	Temperatura	Flusso Luminoso	Dimensione (mm)	Vita (ore)	Prezzo (IVA esclusa)
	<a href="#">LIK120</a>	Riflettore 120° per campana industriale cod. LIKG10060					410/110/		<b>11,31 €</b>
	<a href="#">LIK90</a>	Riflettore 90° per campana industriale cod° LIKG10060					320/160/		<b>15,05 €</b>
	<a href="#">LIT1203650</a>	Plafoniera stagna a LED 220V 1.2m 36W 5000K IP66	220V-240V AC	36W	5000K	3500 lm	1160/120/108	50.000	<b>84,73 €</b>
	<a href="#">LIT1505450</a>	Plafoniera stagna 220V 1.50m 54W 5000K IP66	220V-240V AC	54W	5000K	5100 lm	1560/120/108	50.000	<b>108,29 €</b>





Modello	Codice Prodotto	Descrizione	Tensione	Potenza	Temperatura	Flusso Luminoso	Dimensione (mm)	Vita (ore)	Prezzo (IVA esclusa)
	<a href="#">LIT1204050</a>	Plafoniera stagna in alluminio 220V 1,20m 40W 5000K IP65	100-240V	40W	5000K	3600 lm	1200/91/74	50.000	<b>127,11 €</b>
	<a href="#">LIT1505050</a>	Plafoniera stagna in alluminio 220V 1,50m 50W 5000K IP65	100-240V	50W	5000K	4700 lm	1500/91/74	50.000	<b>164,79 €</b>
	<a href="#">WOT1T860</a>	Portalampada stagna per tubi a LED 1xT8 0.6m	220V-240V AC	1x18W max			683/80/100		<b>13,57 €</b>
	<a href="#">WOT2T8120</a>	Portalampada stagna per tubi a LED2xT8 1.2m	220V-240V AC	2x36W max			1290/115/100		<b>25,43 €</b>
	<a href="#">WOT2T8150</a>	Portalampada stagna per tubi a LED2xT8 1.5m	220V-240V AC	2x58W max			1590/115/100		<b>31,07 €</b>

Modello	Codice Prodotto	Descrizione	Tensione	Potenza	Temperatura	Flusso Luminoso	Dimensione (mm)	Vita (ore)	Prezzo (IVA esclusa)
	<a href="#">WOT2T860</a>	Portalamпада stagna per tubi a LED2xT8 0.6m	220V-240V AC	2x18W max			683/115/100		<b>15,91 €</b>
	<a href="#">LUT2203042</a>	Lampada stradale a LED 220V 30W 4200K IP66	100-240V	30W	4200K	3000 lm	630/250/80	50.000	<b>357,81 €</b>
	<a href="#">LUT2206060</a>	Lampada Stradale a LED 220V 60W 6000K IP66	100-240V	60W	6000K	6000 lm	620/290/150	50.000	<b>466,10 €</b>







# LAMPADE DA INCASSO





Modello	Codice Prodotto	Descrizione	Potenza	Temperatura	Flusso Luminoso	Dimensioni esterne (mm)	Diametro foro per installazione (mm)	Vita (ore)	Prezzo (IVA esclusa)
	<a href="#">LLV1902527</a>	Lampada a LED da incasso 25W, 220V SMD 2835, luce calda	25W	2700K	2200 lm	60/190	165	50.000	<b>54,33 €</b>
	<a href="#">LLV1902542</a>	Lampada a LED da incasso 25W, 220V SMD 2835, luce neutra	25W	4200K	2400 lm	60/190	165	50.000	<b>54,33 €</b>
	<a href="#">LLV2304042</a>	Lampada a LED da incasso 40W, 220V SMD 2835, luce neutra	40W	4200K	3200 lm	86/230	190	50.000	<b>76,05 €</b>
	<a href="#">LML122427</a>	LED cabinet downlight 12VDC 2,4W SMD 2835 IP44, luce calda	2.4W	2700K	240 lm	20/72	55	50.000	<b>7,50 €</b>
	<a href="#">LML122442</a>	LED cabinet downlight 12VDC 2,4W SMD 2835 IP44, luce neutra	2.4W	4200K	240 lm	20/72	55	50.000	<b>7,50 €</b>





# STRISCE LED





Modello	Codice Prodotto	Descrizione	Tensione	Tipo di SMD	Potenza /1m/	N° di LED /1m/	Impermeabilità	Colore Luce	Flusso Luminoso /1m/	Prezzo rotolo 5 m (IVA esclusa)
	<a href="#">LNW3014120W</a>	Striscia a LED 14.4W/m 120LEDs/m, 12V DC, bianca, non-impermeabile	12V DC	SMD 3014	14.4W/m	120/m	NO	bianca	1080 lm	<b>47,82 €</b>
	<a href="#">LNW3014120WW</a>	Striscia a LED 14.4W/m 120LEDs/m, 12V DC, Bianco caldo, non-impermeabile	12V DC	SMD 3014	14.4W/m	120/m	NO	Bianco caldo	1080 lm	<b>47,82 €</b>
	<a href="#">LNW3528120W</a>	Striscia a LED 9.6W/m 120LEDs/m, 12V DC, bianca, non-impermeabile	12V DC	SMD 3528	9.6W/m	120/m	NO	bianca	490 lm	<b>23,73 €</b>
	<a href="#">LNW3528120WW</a>	Striscia a LED 9.6W/m 120LEDs/m, 12V DC, Bianco caldo, non-impermeabile	12V DC	SMD 3528	9.6W/m	120/m	NO	Bianco caldo	490 lm	<b>23,73 €</b>
	<a href="#">LNW505030RGB</a>	Striscia a LED 7.2W/m 30LEDs/m, 12V DC, RGB, non-impermeabile	12V DC	SMD 5050	7.2W/m	30LEDs/m	NO	RGB		<b>24,26 €</b>







Modello	Codice Prodotto	Descrizione	Tensione	Tipo di SMD	Potenza /1m/	N° di LED /1m/	Impermeabilità	Colore Luce	Flusso Luminoso /1m/	Prezzo rotolo 5 m (IVA esclusa)
	<a href="#">LNW505060RGB</a>	Striscia a LED 14.4W/m 60LEDs/m, 12V DC, RGB, non-impermeabile	12V DC	SMD 5050	14.4W/m	60LEDs/m	NO	RGB		<b>31,68 €</b>
	<a href="#">LNW505048DIG</a>	Digital LED Strip, IC D7722, 16pixels/m IP20	12V DC	SMD 5050	11.2W/m	48/m	NO	RGB		<b>137,45 €</b>
	<a href="#">LSNW352860B</a>	Striscia a LED 4.8W/m 60LEDs/m, 12V DC, non-impermeabile, blu	12V DC	SMD 3528	4.8W/m	60/m	NO	Blu		<b>9,44 €</b>
	<a href="#">LSNW352860G</a>	Striscia a LED 4.8W/m 60LEDs/m, 12V DC, non-impermeabile, verde	12V DC	SMD 3528	4.8W/m	60/m	NO	Verde		<b>9,44 €</b>
	<a href="#">LSNW352860R</a>	Striscia a LED 4.8W/m 60LEDs/m, 12V DC, non-impermeabile, rossa	12V DC	SMD 3528	4.8W/m	60/m	NO	Rossa		<b>9,44 €</b>
	<a href="#">LSNW352860W</a>	Striscia a LED 4.8W/m 60LEDs/m, 12V DC, non-impermeabile, bianca	12V DC	SMD 3528	4.8W/m	60/m	NO	6500K	245 lm	<b>9,44 €</b>

Modello	Codice Prodotto	Descrizione	Tensione	Tipo di SMD	Potenza /1m/	N° di LED /1m/	Impermeabilità	Colore Luce	Flusso Luminoso /1m/	Prezzo rotolo 5 m (IVA esclusa)
	<a href="#">LSNW352860WW</a>	Striscia a LED 4.8W/m 60LEDs/m, 12V DC, non-impermeabile, Bianco caldo	12V DC	SMD 3528	4.8W/m	60/m	NO	2700K	245 lm	<b>9,44 €</b>
	<a href="#">LSNW352860Y</a>	Striscia a LED 4.8W/m 60LEDs/m, 12V DC, non-impermeabile, giallo	12V DC	SMD 3528	4.8W/m	60/m	NO	Giallo		<b>9,44 €</b>
	<a href="#">LSNW505030W</a>	Striscia a LED 7.2W/m 30LEDs/m, 12V DC, non-impermeabile, bianca	12V DC	SMD 5050	7.2W/m	30LEDs/m	NO	6500K	410 lm	<b>22,41 €</b>
	<a href="#">LSNW505030WW</a>	Striscia a LED 7.2W/m 30LEDs/m, 12V DC, non-impermeabile, Bianco caldo	12V DC	SMD 5050	7.2W/m	30LEDs/m	NO	3500K	420 lm	<b>22,41 €</b>
	<a href="#">LSNW505060W</a>	Striscia a LED 14.4W/m 60LEDs/m, 12V DC, non-impermeabile, bianca	12V DC	SMD 5050	14.4W/m	60LEDs/m	NO	6500K	820 lm	<b>31,68 €</b>







Modello	Codice Prodotto	Descrizione	Tensione	Tipo di SMD	Potenza /1m/	N° di LED /1m/	Impermeabilità	Colore Luce	Flusso Luminoso /1m/	Prezzo rotolo 5 m (IVA esclusa)
	<a href="#">LSNW505060WW</a>	Striscia a LED 14.4W/m 60LEDs/m, 12V DC, non-impermeabile, Bianco caldo	12V DC	SMD 5050	14.4W/m	60LEDs/m	NO	Bianco caldo	840 lm	<b>31,68 €</b>
	<a href="#">LSW352860B</a>	Striscia a LED 4.8W/m 60LEDs/m, 12V DC, IP65 impermeabile, blu	12V DC	SMD 3528	4.8W/m	60/m	IP65	Blu	/	<b>15,31 €</b>
	<a href="#">LSW352860G</a>	Striscia a LED 4.8W/m 60LEDs/m, 12V DC, IP65 impermeabile, verde	12V DC	SMD 3528	4.8W/m	60/m	IP65	Verde		<b>15,31 €</b>
	<a href="#">LSW352860R</a>	Striscia a LED 4.8W/m 60LEDs/m, 12V DC, IP65 impermeabile, rossa	12V DC	SMD 3528	4.8W/m	60/m	IP65	Rossa		<b>15,31 €</b>
	<a href="#">LSW352860W</a>	Striscia a LED 4.8W/m 60LEDs/m, 12V DC, IP65 impermeabile, bianca	12V DC	SMD 3528	4.8W/m	60/m	IP65	6500K	245 lm	<b>15,31 €</b>





Modello	Codice Prodotto	Descrizione	Tensione	Tipo di SMD	Potenza /1m/	N° di LED /1m/	Impermeabilità	Colore Luce	Flusso Luminoso /1m/	Prezzo rotolo 5 m (IVA esclusa)
	<a href="#">LSW352860WW</a>	Striscia a LED 4.8W/m 60LEDs/m, 12V DC, IP65 impermeabile, Bianco caldo	12V DC	SMD 3528	4.8W/m	60/m	IP65	2700K	245 lm	<b>15,31 €</b>
	<a href="#">LSW352860Y</a>	Striscia a LED 4.8W/m 60LEDs/m, 12V DC, IP65 impermeabile, yellow	12V DC	SMD 3528	4.8W/m	60/m	IP65	Giallo		<b>15,31 €</b>
	<a href="#">LSW505030W</a>	Striscia a LED 7.2W/m 30LEDs/m, 12V DC, IP65 impermeabile, bianca	12V DC	SMD 5050	7.2W/m	30LEDs/m	IP65	6500K	420 lm	<b>27,49 €</b>
	<a href="#">LSW505030WW</a>	Striscia a LED 7.2W/m 30LEDs/m, 12V DC, IP65 impermeabile, Bianco caldo	12V DC	SMD 5050	7.2W/m	30LEDs/m	IP65	3500K	410 lm	<b>27,49 €</b>
	<a href="#">LSW505060W</a>	Striscia a LED 14.4W/m 60LEDs/m, 12V DC, IP65 impermeabile, bianca	12V DC	SMD 5050	14.4W/m	60LEDs/m	IP65	bianca	820 lm	<b>37,06 €</b>
	<a href="#">LSW505060WW</a>	Striscia a LED 14.4W/m 60LEDs/m, 12V DC, IP65 impermeabile, Bianco caldo	12V DC	SMD 5050	14.4W/m	60LEDs/m	IP65	Bianco Caldo	820 lm	<b>37,06 €</b>





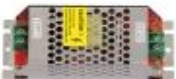

Modello	Codice Prodotto	Descrizione	Tensione	Tipo di SMD	Potenza /1m/	N° di LED /1m/	Impermeabilità	Colore Luce	Flusso Luminoso /1m/	Prezzo rotolo 5 m (IVA esclusa)
	<a href="#">LW3528120W</a>	Striscia a LED 9.6W/m 120LEDs/m, 12V DC, IP65 impermeabile, bianca	12V DC	SMD 3528	9.6W/m	120/m	IP65	bianca	490 lm	<b>28,97 €</b>
	<a href="#">LW3528120WW</a>	Striscia a LED 9.6W/m 120LEDs/m, 12V DC, IP65 impermeabile, Bianco caldo	12V DC	SMD 3528	9.6W/m	120/m	IP65	Bianco caldo	490 lm	<b>28,97 €</b>
	<a href="#">LW505048DIG</a>	Digital LED Strip, IC D7722, 16 pixels/m, IP65	12V DC	SMD 5050	11.2W/m	48/m	IP65	RGB		<b>149,39 €</b>
	<a href="#">LW505030RGB</a>	Striscia a LED 7.2W/m 30LEDs/m, 12V DC, IP65 impermeabile, RGB	12V DC	SMD 5050	7.2W/m	30LEDs/m	IP65	RGB		<b>29,30 €</b>
	<a href="#">LW505060RGB</a>	Striscia a LED 14.4W/m 60LEDs/m, 12V DC, IP65 impermeabile, RGB	12V DC	SMD 5050	14.4W/m	60LEDs/m	IP65	RGB		<b>37,65 €</b>

**Attenzione: I prezzi sono da intendersi per Strisce LED in rotolo da 5 metri**



# ALIMENTATORI PER LED

Modello	Codice Prodotto	Descrizione	Tensione	Potenza	Impermeabilità	Prezzo (IVA esclusa)
	ZAM502	Alimentatore inverter di emergenza per LED con inclusa batteria Ni-Cd 12V 2200mAh	100-270V AC	50W	NO	114,74 €
	DZL1245	Alimentatore dimmerabile da dimmer TRIAC per LED 12V DC 45W	12V DC	45W	NO	50,79 €
	ZNWP1212	Alimentatore per strisce LED, mini, 12W 12V DC, non-impermeabile	12V DC	12W	NO	7,16 €
	ZNWP1236	Alimentatore per strisce LED, mini, 36W 12V DC, non-impermeabile	12V DC	36W	NO	13,13 €
	ZSLNW12120	Alimentatore per strisce LED, 120W 12V DC, non-impermeabile	12V DC	120W	NO	24,52 €
	ZSLNW1215	Alimentatore per strisce LED 15W, 12V DC, non-impermeabile	12V DC	15W	NO	8,84 €





Modello	Codice Prodotto	Descrizione	Tensione	Potenza	Impermeabilità	Prezzo (IVA esclusa)
	<a href="#">ZSLNW12150</a>	Alimentatore per strisce LED 150W, 12V DC, non-impermeabile	12V DC	150W	NO	<b>25,71 €</b>
	<a href="#">ZSLNW1225</a>	Alimentatore per strisce LED 25W, 12V DC, non-impermeabile	12V DC	25W	NO	<b>11,22 €</b>
	<a href="#">ZSLNW12250</a>	Alimentatore per strisce LED, 250W 12V DC, non-impermeabile	12V DC	250W	NO	<b>38,25 €</b>
	<a href="#">ZSLNW1240</a>	Alimentatore per strisce LED 40W, 12V DC, non-impermeabile	12V DC	40W	NO	<b>14,72 €</b>
	<a href="#">ZSLNW1275</a>	Alimentatore per strisce LED 75W, 12V DC, non-impermeabile	12V DC	75W	NO	<b>20,33 €</b>
	<a href="#">ZSLNW5200</a>	Power supply for LED lighting, non-waterproof, 5V DC, 200W	5V DC	200W	NO	<b>41,84 €</b>





Modello	Codice Prodotto	Descrizione	Tensione	Potenza	Impermeabilità	Prezzo (IVA esclusa)
	ZSLP1212	Alimentatore per strisce LED 12W, 12V DC non-impermeabile, plastica	12V DC	12W	NO	5,02 €
	ZSLP1224	Alimentatore per strisce LED 24W, 12V DC, non-impermeabile, plastica	12V DC	24W	NO	7,79 €
	ZSLP1260	Alimentatore per strisce LED 60W, 12V DC, non-impermeabile, plastic	12V DC	60W	NO	14,82 €
	ZSLW1220	Alimentatore per strisce LED 20W, 12V DC, IP67 impermeabile	12V DC	20W	IP67	14,45 €
	ZSLW1230	Alimentatore per strisce LED 30W, 12V DC, IP67 impermeabile	12V DC	30W	IP67	18,05 €
	ZWP12100	Alimentatore per strisce LED, 100W 12V DC, impermeabile, plastic	12V DC	100W	IP67	45,41 €
	ZWP1236	Alimentatore per strisce LED, 36W 12V DC, impermeabile	12V DC	36W	IP67	19,73 €











Modello	Codice Prodotto	Descrizione	Tensione	Potenza	Impermeabilità	Prezzo (IVA esclusa)
	ZWP1260	Alimentatore per strisce LED,60W 12V DC, impermeabile, plastic	12V DC	60W	IP67	31,68 €
	ZWP1275	Alimentatore per strisce LED,75W 12V DC, impermeabile, plastic	12V DC	75W	IP67	34,65 €
	ZWP24100	Alimentatore per strisce LED, impermeabile, 24V DC, 100W	24V DC	100W	IP67	45,41 €







# CONTROLLER/SENSORI PER LED







Modello	Codice Prodotto	Descrizione	Tensione	Potenza	Controllo	Prezzo (IVA esclusa)
	<a href="#">DDL22012</a>	Driver per dimmerare pannelli a LED a 12W	220V-240V AC	12W		15,21 €
	<a href="#">DDL22018</a>	Driver per dimmerare pannelli a LED a 18W	220V-240V AC	18W		17,37 €
	<a href="#">DDL22045</a>	Driver per dimmerare pannelli a LED a 45W	220V-240V AC	45W		27,15 €
	<a href="#">DDL22045F</a>	Driver per dimmerare con 0-10V DC, PWM, potenziometro 100K control per pannelli a LED da 45W	220V-240V AC	45W		28,26 €





Modello	Codice Prodotto	Descrizione	Tensione	Potenza	Controllo	Prezzo (IVA esclusa)
	DIGC1RF	RF MINI controller for digital LED strips	5-24V DC	800 pixels	RF	21,72 €
	DIGC2	RF SLAVE controller for digital LED strips	12-24V DC	800 pixels		22,83 €
	DIGC2RF	RF MASTER controller for digital LED strips	12-24V DC	800 pixels	RF	29,34 €
	MKRF2	RF Telecomando a pulsanti, 2 canali, 220V AC	220V	2x300W	RF	13,05 €
	MKRF3	RF Telecomando a pulsanti, 3 canali, 220V AC	220V	3x300W	RF	14,67 €

Modello	Codice Prodotto	Descrizione	Tensione	Potenza	Controllo	Prezzo (IVA esclusa)
	MKRF4	RF Telecomando a pulsanti, 4 canali, 220V AC	220V	4x300W	RF	16,29 €
	MKRF6	RF Telecomando a pulsanti. 6 canali, 220V AC	220V	6x300W	RF	19,56 €
	P1SCD	Professional RD Dimmer for single colour LED light without remote control	5-24V DC	120W (12V)	RF	24,99 €
	P1SCDRF	Professional RF Dimmer for single colour LED light	5-24V DC	120W (12V)	RF	30,42 €





Modello	Codice Prodotto	Descrizione	Tensione	Potenza	Controllo	Prezzo (IVA esclusa)
	P2SC	Professional RF controller for single colour LED light without remote control	5-24V DC	120W (12V)	RF	24,99 €
	P2SCRF	Professional RF controller for single colour LED light	5-24V DC	120W (12V)	RF	30,42 €
	P3RGB	Professional RF controller for RGB LED light without remote control	5-24V DC	126W (12V)	RF	29,34 €
	P3RGBRF	Professional RF controller for RGB LED light	5-24V DC	126W (12V)	RF	35,85 €
	P4RGBBLU	Professional Bluetooth controller for RGB LED light	6-24V DC	126W (12V)	Bluetooth	70,62 €





Modello	Codice Prodotto	Descrizione	Tensione	Potenza	Controllo	Prezzo (IVA esclusa)
	RFD8	LED Dimmer with RF remote control, 96W 12V DC	12-24V DC	96W	RF	12,81 €
	RGBAMP12A	Amplificatore per strce a LED RGB, 144W, 12 DC	12V DC	144W		12,06 €
	RGBAMP24A	Amplifier for RGB LED Lights 24A, 12-24V DC, 288W	12-24V DC	288W		24,45 €
 	RGBAMPM	Mini amplificatore per lamapde a LED RGB, 72W, 6A, 5-24V, non-waterproof	5-24V DC	72W		5,22 €
 	RGBCM	Mini Controller per lamapde LED RGB, 72W, 6A, 5-24V, non-impermeabile	5-24V DC	72W		5,22 €







Modello	Codice Prodotto	Descrizione	Tensione	Potenza	Controllo	Prezzo (IVA esclusa)
	RGBIRC24	RGB controller with IR remote control, 72W 6	12-24V DC	72W	IR	6,51 €
	RGBRFC4	RF Controller for RGB LED lights 144W, 12V DC	12-24V DC	144W	RF	24,99 €
	RGBRFC5T	RF Controller per RGB lampade a LED 216W, 12V DC	12V DC	216W	RF	40,20 €
	RGBRFC6A	RF MINI Controller for RGB LED light	5-24V DC	72W (12V)	RF	15,21 €
	RGBRFCM	RF mini controller for RGB LED Lights, 72W, 12A, 12-24V, non-waterproof	12-24V DC	72W	RF	15,42 €
	RGBRFM12A	RF Music Controller for RGB LED Lights, 12A, 12-24V DC, 144W	12-24V DC	144W	RF	30,42 €

Modello	Codice Prodotto	Descrizione	Tensione	Potenza	Controllo	Prezzo (IVA esclusa)
	RGBRFM6A	RF Music Controller for RGB LED Lights, 6A, 12-24V DC, 72W	12-24V DC	72W	RF	20,10 €
	RGBWIFIC	WiFi Controller for RGB LED Lights, 144W, 12A, 12-24V	12-24V DC	144W		80,40 €
	SCAMPM	Mini amplifier for Single colour LED Lights, 72W, 6A, 5-24V, non-waterproof	5-24V DC	72W		5,22 €
	SCDM	Mini dimmer for Single colour LED Lights, 72W, 6A, 5-24V, non-waterproof	5-24V DC	72W		5,22 €
	SCRFC5A	RF MINI Controller for single colour LED light	5-24V DC	60W (12V)	RF	14,13 €











Modello	Codice Prodotto	Descrizione	Tensione	Potenza	Controllo	Prezzo (IVA esclusa)
	SCRFCM	RF mini controller for Single colour LED Lights, 72W, 6A, 5-24V, non-waterproof	5-24V DC	72W	RF	15,42 €
	SCWIFID	WiFi Controller for Single colour LED Lights, 144W, 12A, 12-24V, non-impermeabile	12-24V DC	144W		78,78 €
	SDC1	SD Card 1-port controller for digital LED strips and modules	5-24V DC	2048 pixels		136,89 €
	SDC8	SD Card 8-port controller for digital LED strips and modules	5-24V DC	8x2048 pixels		398,73 €
	AKRS	Automatic radar sensor wall switch	220V-240V AC	500W		19,56 €





Modello	Codice Prodotto	Descrizione	Tensione	Potenza	Controllo	Prezzo (IVA esclusa)
	MSOM	Sensore a microonde da parete	220V-240V AC	1200W/300W		19,02 €
	MSV	Sensore a microonde da incasso	220V-240V AC	1200W/300W		19,56 €
	SB	Sensore di prossimità (interruttore)	220V-240V AC	500/200W		18,48 €
	SDMF	Mini Light Control Sensor 1600W 220V	220V-240V AC	1600W		7,05 €
	SDMP	Mini Sensore di movimento 360	220V-240V AC	800W		8,58 €





Modello	Codice Prodotto	Descrizione	Tensione	Potenza	Controllo	Prezzo (IVA esclusa)
	SDOMBL	Sensore di movimento da parete	220V-240V AC	1200W/300W		10,32 €
	SDV	Standalone Sensore di movimento, 360	220V-240V AC	1200W		10,44 €
	SDVM	Outdoor Sensore di movimento, 360	220V-240V AC	1200W		8,79 €
	SDVMBL	Sensore di movimento nero 180	220V-240V AC	1200W		8,85 €
	SDVMF	Sensore crepuscolare 1200W 220V	220V-240V AC	1200W		3,60 €
	SDVMWH	Sensore di movimento bianco 180	220V-240V AC	1200W		8,85 €





# ACCESSORI PER STRISCE LED

Modello	Codice Prodotto	Descrizione	Pcs in a set	Prezzo (IVA esclusa)
	AP201	Profilo di alluminio per strisce LED, shallow, 2m	1 pcs.	13,42 €
	AP201KT	Set di terminali for Profilo di alluminio AP201 - 2 pcs.	2 pcs.	0,94 €
	AP201MS	Set di staffe per il montaggio di Profilo di alluminio AP201 - 2 pcs.	2 pcs.	0,62 €
	AP202	Profilo di alluminio per strisce LED, universal, 2m	1 pcs.	19,79 €





Modello	Codice Prodotto	Descrizione	Pcs in a set	Prezzo (IVA esclusa)
	AP202KT	Set di terminali for Profilo di alluminio AP202 - 2 pcs.	2 pcs.	1,25 €
	AP202MS	Set di staffe per il montaggio di Profilo di alluminio AP202 - 2 pcs.	2 pcs.	0,62 €
	AP203	Profilo di alluminio per strisce LED, round, 2m	1 pcs.	19,79 €
	AP203KT	Set di terminali for Profilo di alluminio AP203 - 2 pcs.	2 pcs.	0,94 €
	AP203MS	Set di staffe per il montaggio di Profilo di alluminio AP203 - 2 pcs.	pcs.	0,62 €



Modello	Codice Prodotto	Descrizione	Pcs in a set	Prezzo (IVA esclusa)
	AP204	Profilo di alluminio per strisce LED, angolare 2m	1 pcs.	16,25 €
	AP204KT	Set di terminali for Profilo di alluminio AP204 - 2 pcs.	2 pcs.	0,94 €
	AP204MS	Set di staffe per il montaggio di Profilo di alluminio AP204 - 2 pcs.	2 pcs.	0,94 €
	AP205	Profilo di alluminio per strisce LED, angular with board 2m	1 pcs.	21,19 €
	AP205KT	Set di terminali for Profilo di alluminio AP205 - 2 pcs.	2 pcs.	0,94 €



Modello	Codice Prodotto	Descrizione	Pcs in a set	Prezzo (IVA esclusa)
	AP205MS	Set di staffe per il montaggio di Profilo di alluminio AP205 - 2 pcs.	2 pcs.	0,62 €
	AP206	Profilo di alluminio per strisce LED, deep surface, 2m	1 pcs.	16,25 €
	AP206KT	Set di terminali for Profilo di alluminio AP206 - 2 pcs.	2 pcs.	0,94 €
	AP206MS	Set di staffe per il montaggio di Profilo di alluminio AP206 - 2 pcs.	2 pcs.	0,62 €
	AP207	Profilo di alluminio per strisce LED, shallow, 2m	1 pcs.	12,71 €

Modello	Codice Prodotto	Descrizione	Pcs in a set	Prezzo (IVA esclusa)
	<a href="#">AP207KT</a>	Set di terminali for Profilo di alluminio AP207 - 2 pcs.	2 pcs.	<b>0,94 €</b>
	<a href="#">AP207MS</a>	Set di staffe per il montaggio di Profilo di alluminio AP207 - 2 pcs.	2 pcs.	<b>0,62 €</b>
	<a href="#">GKL3528</a>	Flexible Connector per strisce LED SMD 3528, 20pcs.	20 pcs.	<b>16,95 €</b>
	<a href="#">GKL5050</a>	Flexible Connector per strisce LED SMD 5050, 20 pcs.	20 pcs.	<b>16,95 €</b>
	<a href="#">GKLRGB</a>	Flexible Connector for RGB Led flexible strip SMD 5050, 20 pcs.	20 pcs.	<b>16,95 €</b>



Modello	Codice Prodotto	Descrizione	Pcs in a set	Prezzo (IVA esclusa)
	<a href="#">GKLRGBM4</a>	Flexible Connector for RGB Led flexible strip 4 pins, 20 pcs.	20 pcs.	<b>16,95 €</b>
	<a href="#">KL3528</a>	Connector per strisce LED SMD 3528, 20 pcs.	20 pcs.	<b>13,18 €</b>
	<a href="#">KL5050</a>	Connector per strisce LED SMD 5050, 20 pcs.	20 pcs.	<b>13,18 €</b>
	<a href="#">KLRGB</a>	Connector for RGB Led flexible strip SMD 5050, 20 pcs.	20 pcs.	<b>13,18 €</b>
	<a href="#">SPRGBL</a>	PIN Connector for RGB Led flexible strip, 20 pcs.	20 pcs.	<b>6,97 €</b>

Modello	Codice Prodotto	Descrizione	Pcs in a set	Prezzo (IVA esclusa)
	ZGBF	Flexible Power Connector (Female) 20 pcs.	20 pcs.	16,95 €
	ZGBM	Flexible Power Connector (Male) 20 pcs.	20 pcs.	16,95 €
	KW2PM19	Waterproof M19 connector, 2 pins, IP67, 10 pcs.	10 pcs.	84,73 €
	KW3PL20	Waterproof L20 connector, 3 pins, IP67, 10 pcs.	10 pcs.	65,91 €
	KW3PT20	Waterproof T20 connector, 3 pins, IP67, 10 pcs.	10 pcs.	98,88 €





Modello	Codice Prodotto	Descrizione	Pcs in a set	Prezzo (IVA esclusa)
	ZKSTKB	Power cable with plug and switch, black	1 pcs.	2,08 €
	ZKSTKW	Power cable with plug and switch, white	1 pcs.	2,08 €

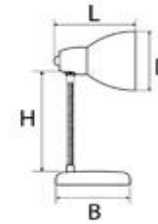



**Attenzione : I prezzi si riferiscono ad 1 set**





# LAMPADE - PLAFONIERE













Legenda:  
 D - Diametro del tubo;  
 L - Lunghezza portalampada  
 H - Altezza tubo flessibile;  
 B - Diametro della base.

Modello	Codice Prodotto	Descrizione	Tensione	Potenza	Attacco	Temperatura Coleore	Flusso Luminoso	Dimensione D/L/H/B (mm)	Vita (ore)	Prezzo (IVA esclusa)
	FOT2GU10S	Portalampada da esterno, 2xGU10, IP44, argento	220V	2x35W	2xGU10	/	/	167/60/105	/	44,38 €
	FOTE27B	Portalampada da esterno, E27, IP44, nera	220V	60W	E27	/	/	265/90/90	/	31,68 €
	FOTE27MG	Portalampada da esterno, E27, IP44, grigia	220V	18W	E27	/	/	368/160/130	/	49,42 €
	FOTE27PG	Portalampada da esterno, E27, IP54, grigia	220V	75W	E27	/	/	206/105	/	49,42 €
	FOTG9B	Portalampada da esterno, G9, IP65, nera	220V	40W	G9	/	/	152/80/80	/	49,42 €







Modello	Codice Prodotto	Descrizione	Tensione	Potenza	Attacco	Temperatura Coleore	Flusso Luminoso	Dimensione D/L/H/B (mm)	Vita (ore)	Prezzo (IVA esclusa)
	<a href="#">LEDOTC6</a>	LED lamp with clip, silver	220V-240V AC	6W		4000K	420 lm	118/404/119	50000	<b>29,16 €</b>
	<a href="#">LLS345</a>	Lampada a LED da parete - 3W, 4500K, argento	220V-240V AC	3W		4500K	200 lm	33/58/250/78	40000	<b>21,56 €</b>
	<a href="#">LOTB1042</a>	LED bathroom lighting fixture, 2x5W, 4200K, chrome, IP44	220V-240V AC	10W		4200K	800 lm	137/250/30	50000	<b>88,73 €</b>
	<a href="#">LOTB1527</a>	LED bathroom lighting fixture, 3x5W, 2700K, chrome, IP44	220V-240V AC	15W		2700K	1200 lm	137/385/30	50000	<b>121,70 €</b>
	<a href="#">LOTB1542</a>	LED bathroom lighting fixture, 3x5W, 4200K, chrome, IP44	220V-240V AC	15W		4200K	1200 lm	137/385/30	50000	<b>121,70 €</b>





Modello	Codice Prodotto	Descrizione	Tensione	Potenza	Attacco	Temperatura Coleore	Flusso Luminoso	Dimensione D/L/H/B (mm)	Vita (ore)	Prezzo (IVA esclusa)
	LOTB527	LED bathroom lighting fixture, 5W, 2700K, chrome, IP44	220V-240V AC	5W		2700K	420 lm	135/90/28	50000	58,31 €
	LOTB542	LED bathroom lighting fixture, 5W, 4200K, chrome, IP44	220V-240V AC	5W		4200K	420 lm	135/90/28	50000	58,31 €
	LOTB827	LED Bathroom lighting fixture, 8W, 2700K, chrome, IP44	220V	8W		2700K	480 lm	490/145	50000	69,72 €
	LOTB842	LED Bathroom lighting fixture, 8W, 4200K, chrome, IP44	220V	8W		4200K	480 lm	490/145	50000	69,72 €
	NOTLED6	LED Desk lamp, nera	220V-240V AC	6W		4000K	420 lm	118/360/137	50000	31,68 €







Modello	Codice Prodotto	Descrizione	Tensione	Potenza	Attacco	Temperatura Coleore	Flusso Luminoso	Dimensione D/L/H/B (mm)	Vita (ore)	Prezzo (IVA esclusa)
	LEDOTC	Lampada LED da tavolo con pinza - 3W 4000K	220V-240V AC	3W	/	4000K	210 lm	36/49/370	30000	22,30 €
	NOTLED	LED Desk lamp - 3W, 4000K, silver	220V-240V AC	3W	/	4000K	210 lm	36/49/370/119	30000	23,59 €
	OTC	Desk clip lamp with 9W E14 energy saving bulb, black	220V-240V AC	/	E14	/	/	122/150/285	/	16,17 €
	OTS2LCH	Portalamпада da parete, 2x3W, cromata	220V-240V AC	6W	/	/	/	60/260/70	/	59,57 €





Modello	Codice Prodotto	Descrizione	Tensione	Potenza	Attacco	Temperatura Coleore	Flusso Luminoso	Dimensione D/L/H/B (mm)	Vita (ore)	Prezzo (IVA esclusa)
	OTS2LSN	Portalampada da parete, 2x3W, nichel satinato	220V-240V AC	6W	/	/	/	60/260/70	/	59,57 €
	OTSGLCH	Portalampada da parete con lampadina a led flessibile, 40W, E27, chrome	220V-240V AC	40W	E27	/	/	30/100/379/140	/	62,13 €
	OTSGLSN	Portalampada da parete con lampadina a led flessibile, 40W, E27, satin nickel	220V-240V AC	40W	E27	/	/	30/100/379/140	/	62,13 €
	OTSPLCH	Portalampada da parete con lampadina a led orientabile, 40W, E27, chrome	220V-240V AC	40W	E27	/	/	30/100/105/140	/	62,13 €
	OTSPLSN	Portalampada da parete con lampadina a led orientabile, 40W, E27, satin nickel	220V-240V AC	40W	E27	/	/	30/100/105/140	/	62,13 €
	NOTF	Desk lamp with 13W E27 energy saving lamp, white	220V-240V AC	/	E27	/	/	122/150/285/136	/	19,67 €







Modello	Codice Prodotto	Descrizione	Tensione	Potenza	Attacco	Temperatura Coleore	Flusso Luminoso	Dimensione D/L/H/B (mm)	Vita (ore)	Prezzo (IVA esclusa)
	SOTCW	Silicone lamp with clip - E14, white	220V-240V AC	/	E14	/	/	84/136/270	/	18,13 €
	SOTCP	Silicone lamp with clip - E14, pink	220V-240V AC	/	E14	/	/	84/136/270	/	18,13 €
	SOTCB	Silicone lamp with clip - E14, blue	220V-240V AC	/	E14	/	/	84/136/270	/	18,13 €
	TARW	Textile lamp shade, cylinder, white	/	/	/	/	/	160/170	/	10,78 €
	TASW	Textile lamp shade, square, white	/	/	/	/	/	160/160/170	/	10,78 €
	LWP2201445	Plafoniera led quadrata stagna 220V 14W 4500K IP66	220V-240V AC	14W	/	4500K	1500 lm	288/288/88	50000	63,39 €

Modello	Codice Prodotto	Descrizione	Tensione	Potenza	Attacco	Temperatura Coleore	Flusso Luminoso	Dimensione D/L/H/B (mm)	Vita (ore)	Prezzo (IVA esclusa)
	<a href="#">SPLR1240</a>	Plafoniera con circolina a LED con sensore radar 12W 4000K	220V-240V AC	12W		4000K	950 lm	255/75	50000	<b>34,23 €</b>
	<a href="#">SPL1240</a>	Plafoniera con circolina a LED, 12W 4000K, 220-240V	220V-240V AC	12W		4000K	950 lm	255/75	50000	<b>22,82 €</b>
	<a href="#">SPL1227</a>	Plafoniera con circolina a LED 12W 2700K	220V-240V AC	12W		2700K	950 lm	255/75	50000	<b>22,82 €</b>
	<a href="#">SPLD1227</a>	Plafoniera decorata con circolina a LED 12W 2700K	220V-240V AC	12W		2700K	950 lm	265/85	50000	<b>25,34 €</b>
	<a href="#">SPLD1240</a>	Plafoniera decorata con circolina a LED 12W 4000K	220V-240V AC	12W		4000K	950 lm	265/85	50000	<b>25,34 €</b>





Modello	Codice Prodotto	Descrizione	Tensione	Potenza	Attacco	Temperatura Coleore	Flusso Luminoso	Dimensione D/L/H/B (mm)	Vita (ore)	Prezzo (IVA esclusa)
	<a href="#">SPLD1827</a>	LED decorative ceiling lamp 18W 2700K	220V-240V AC	18W		2700K	1350 lm	345/105	50000	<b>32,97 €</b>
	<a href="#">SPLD1840</a>	LED decorative ceiling lamp 18W 4000K	220V-240V AC	18W		4000K	1350 lm	345/105	50000	<b>32,97 €</b>
	<a href="#">SPL2027</a>	Plafoniera decorata con circolina a LED 20W 2700K	220V-240V AC	20W		2700K	1600 lm	405/115	50000	<b>39,31 €</b>
	<a href="#">SPLD2427</a>	LED decorative ceiling lamp 24W 2700K	220V-240V AC	24W		2700K	1850 lm	405/105	50000	<b>41,83 €</b>
	<a href="#">SPLD2440</a>	LED decorative ceiling lamp 24W 4000K	220V-240V AC	24W		4000K	1850 lm	405/105	50000	<b>41,83 €</b>
	<a href="#">SPLD2840</a>	Plafoniera decorata con circolina a LED 28W 4000K	220V-240V AC	28W		4000K	2200 lm	405/115	50000	<b>50,72 €</b>

Modello	Codice Prodotto	Descrizione	Tensione	Potenza	Attacco	Temperatura Coleore	Flusso Luminoso	Dimensione D/L/H/B (mm)	Vita (ore)	Prezzo (IVA esclusa)
	<a href="#">SPLD2827</a>	Plafoniera decorata con circolina a LED 28W 2700K	220V-240V AC	28W	/	2700K	2200 lm	405/115	50000	50,72 €
	<a href="#">LLK1D</a>	LED Plug-in lamp with dimmer	220V-240V AC	1W	/	2700K	70 lm	48/365/38	50000	23,45 €
	<a href="#">OTB2C</a>	Portalampada da bagno, 2xG9, cilindrico, cromato, IP44	220V	2*25W	G9	/	/	/	/	30,42 €
	<a href="#">OTB2K</a>	Portalampada da bagno, 2xG9, quadrato, cromato, IP44	220V	2*25W	G9	/	/	/	/	37,91 €
	<a href="#">OTBS2C</a>	Portalampada da bagno con sensore, 2xE14, cilindrica, IP44	220V-240V AC	2x40W	E14	/	/	355/90/63	/	47,53 €





# BATTERIE

Modello	Codice Prodotto	Descrizione	Batterie per blister	Prezzo blister (IVA esclusa)
	UDAAALR034B	Batteria Ultradigital Alkaline 1.5V AAA (LR03), 4 pcs./blister	4 pcs.	1,74 €
	UDAALR64B	Batteria Ultradigital Alkaline 1.5V AA (LR6), 4 pcs./blister	4 pcs.	1,74 €
	DLR202B	Batteria Super Alkalina 1.5V (LR20), 2 pcs./blister	2 pcs.	3,41 €
	CLR142B	Batteria Super Alkalina 1.5V (LR14), 2pcs./blister	2 pcs.	2,37 €

Modello	Codice Prodotto	Descrizione	Batterie per blister	Prezzo blister (IVA esclusa)
	AAALR034B	Batteria Super Alkalina 1.5V AAA (LR03), 4pcs./blister	4 pcs.	1,48 €
	AALR64B	Batteria Super Alkalina 1.5V AA (LR6), 4pcs./blister	4 pcs.	1,48 €
	A271B	Batteria Super Alkalina 12V (A27), 1pc./blister	1 pcs.	0,75 €
	A231B	Batteria Super Alkalina 12V (A23), 1pc./blister	1 pcs.	0,75 €
	9V6LR611B	Batteria Super Alkalina 9V (6LR61), 1pc./blister	1 pcs.	2,11 €





Modello	Codice Prodotto	Descrizione	Batterie per blister	Prezzo blister (IVA esclusa)
	CR2032B	Batteria al litio CR2032, 3V, 2 pcs./blister	2 pcs.	0,75 €
	CR2025B	Batteria al litio CR2025, 3V, 2 pcs./blister	2 pcs.	0,75 €
	CR2016B	Batteria al litio CR2016, 3V, 2 pcs./blister	2 pcs.	0,75 €
	CR1632B	Batteria al litio CR1632, 3V, 2 pcs./blister	2 pcs.	0,86 €



# PRODOTTI INNOVATIVI

Modello	Codice Prodotto	Descrizione	Prezzo (IVA esclusa)
<b>PRODOTTI LED</b>			
	MF1WCREE	High Power LED Multifunctional Torch, 1 W Minimum order quantity: 72	11,03 €
	P1WMS	High Power LED Flashlight 1 W Minimum order quantity: 100	5,68 €
	P3WCREEZ	LED Flashlight 3 W CREE Minimum order quantity: 100	11,93 €
	P3WMSZ	High Power LED Flashlight 3 W Minimum order quantity: 100	8,01 €



Modello	Codice Prodotto	Descrizione	Prezzo (IVA esclusa)
	PSLB	Portable LED Lamp - white light Minimum order quantity: 24	16,72 €
	PSLJ	Portable LED Lamp - yellow light Minimum order quantity: 24	16,72 €
	PZG3WCREEZ	LED Head Lamp 3 W CREE XR-E Q3 Minimum order quantity: 60	11,93 €
	SDSEL	LED glass candle - oval shape Minimum order quantity: 24	7,11 €
	SDSHEX	LED glass candle - hexagon Minimum order quantity: 24	7,73 €
	SDSKR	LED glass candle - tulip shape Minimum order quantity: 24	6,52 €

Modello	Codice Prodotto	Descrizione	Prezzo (IVA esclusa)
	SDSKV	LED glass candle - square Minimum order quantity: 24	7,73 €
	SDSOV	LED glass candle - ball shape Minimum order quantity: 24	6,78 €
	SNSB	LED Faucet Light Minimum order quantity: 120	8,01 €
	SSD	LED Shower Head Minimum order quantity: 50	17,36 €
	USBLL	USB LED lamp mini, black Minimum order quantity: 100	5,32 €

Modello	Codice Prodotto	Descrizione	Prezzo (IVA esclusa)
	<p>USBLLB</p>	<p>USB LED lamp - ball, chrome Minimum order quantity: 72</p>	<p>6,86 €</p>
	<p>USBLLK</p>	<p>USB LED lamp with switch, black Minimum order quantity: 80</p>	<p>5,32 €</p>